

GSM Door Phone System

System Installation, Setting and Operation Manual



User Manual (263-S- V1)

Please read this user manual completely before operating this system and keep it in a safe place for future reference.

TABLE OF CONTENTS

TABLE OF CONTENTS	1
IMPORTANT SAFETY INSTRUCTIONS	2
UNPACKING YOUR SYSTEM	3
SYSTEM DIAGRAMS	
Front View	4
Back View	5
Wall Mounting Bracket	6
INSTALLATION	
GSM Door Phone.....	7
Wiring Diagram & Wiring Instructions	9
OPERATION	
Power ON/OFF	10
Manager Mode and Functions	10
MANAGER SETTINGS	
Change Manager Password	11
Store Manager Phone Number	11
Set Minutes for Talk Time	12
VOLUME SETTING	
Change Microphone Volume	12
Change Speaker Volume	13
Change Speaker Volume During Conversation	13
DOOR SETTING	
Enable/Disable Door Lock Open by Password	13
Change Door Opening Password	14
Door Opening Time	14
CALLING SETTING	
Set Calling Time	15
Change the Calling by List	15
SUBSCRIBER ID NUMBER SETTING	
Setup Subscriber ID Number	16
CONTACTING A SUBSCRIBER	17
OPEN THE DOOR REMOTELY	17
GO BACK TO STANDBY SCREEN AUTOMATICALLY	17
SIM CARD	18
CALL MANAGER	18
MASTER RESET	18

Thank you for purchasing the GSM Door Phone. To ensure that you enjoy the full capacity of this product, please read this user manual before proceeding. Be sure to keep this manual for future reference in case any challenge or question should arise. We hope you enjoy your new GSM Door Phone.





IMPORTANT SAFETY INSTRUCTIONS

When using your GSM Door Phone, basic safety precautions should always be followed to reduce the risk of fire, electric shock and personal injury. Please read the following before using your equipment.

1. Follow all warnings and instructions on the product.
2. Unplug the product before cleaning. Do not use liquid cleaners or aerosol cleaners. Use a damp cloth for cleaning.
3. Do not use this product near water.
4. Do not allow anything to rest on power cords. Do not place this product in a location where the cords can be stepped on or where someone can trip over them.
5. Do not use this product near an area where there is a potential of gas leaks or near any fumes that can be explosive.
6. Do not place this equipment near or over a radiator or any other heat source.
7. Use **ONLY** the power adapter supplied with the system.
8. Do not overload the wall outlet or power cord where the power adapter is installed. This can result in fire or electric shock.
9. This equipment is to be opened **ONLY** by a qualified service technician. There are no user serviceable parts inside. Opening this equipment may expose you to dangerous voltage and other risks. Incorrect reassembly of this equipment may result in electric shock.
10. Avoid spilling liquid on this equipment and do not insert any objects through the ventilation slots.
11. Avoid using this equipment during an electrical storm. There is a remote risk of electrical shock from lightning.
12. Do not use this equipment other than for its purpose intended by the manufacture. Use **ONLY** the equipment provided by the manufacturer.

UNPACKING YOUR SYSTEM

Your GSM Door Phone system will include the followings:

1 x Door phone unit	
1 x AC power adapter	
1 x GSM antenna	
1 x Wall mounting bracket	
1 x Wire	
4 x screws for mounting bracket	
2 x screws for door phone	
1 x User manual	

Optional Accessories

◆ Rain hood	
◆ Antenna bracket	

System Diagram (Front View)

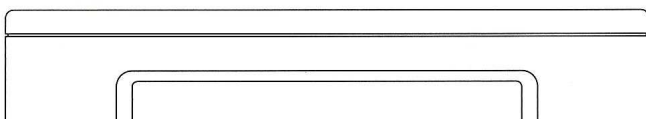

← Acrylic cover

Speaker

LCD display

Keypad

0~9: Number keys

F1: Menu/Exit key

F2: Delete key

F3: ABC/abc/123 exchange button

*****: Volume & select up key

#: Volume & select down key

Microphone

Bottom cover

System Diagram (Back View)

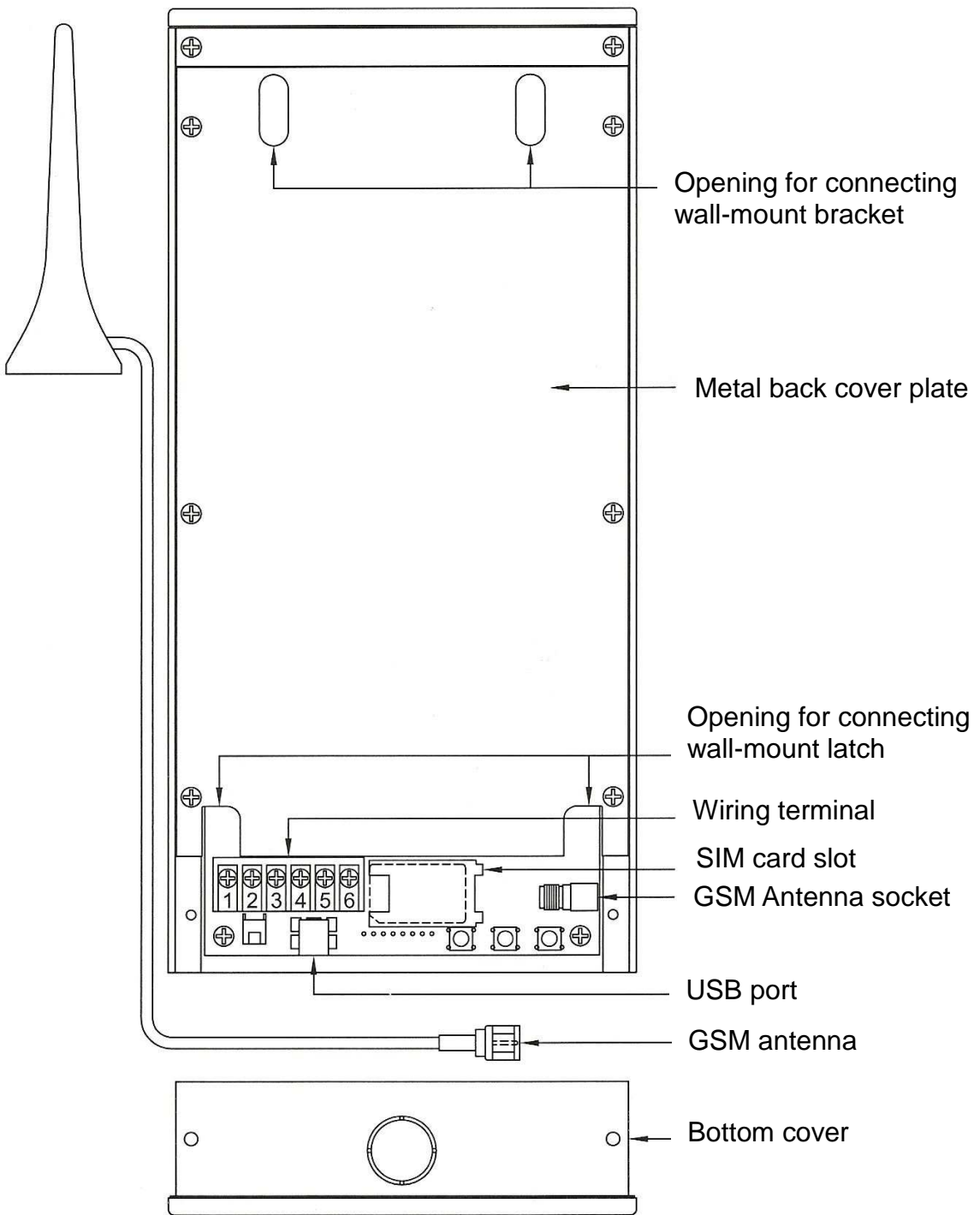

System Diagram (Wall Mounting Bracket)

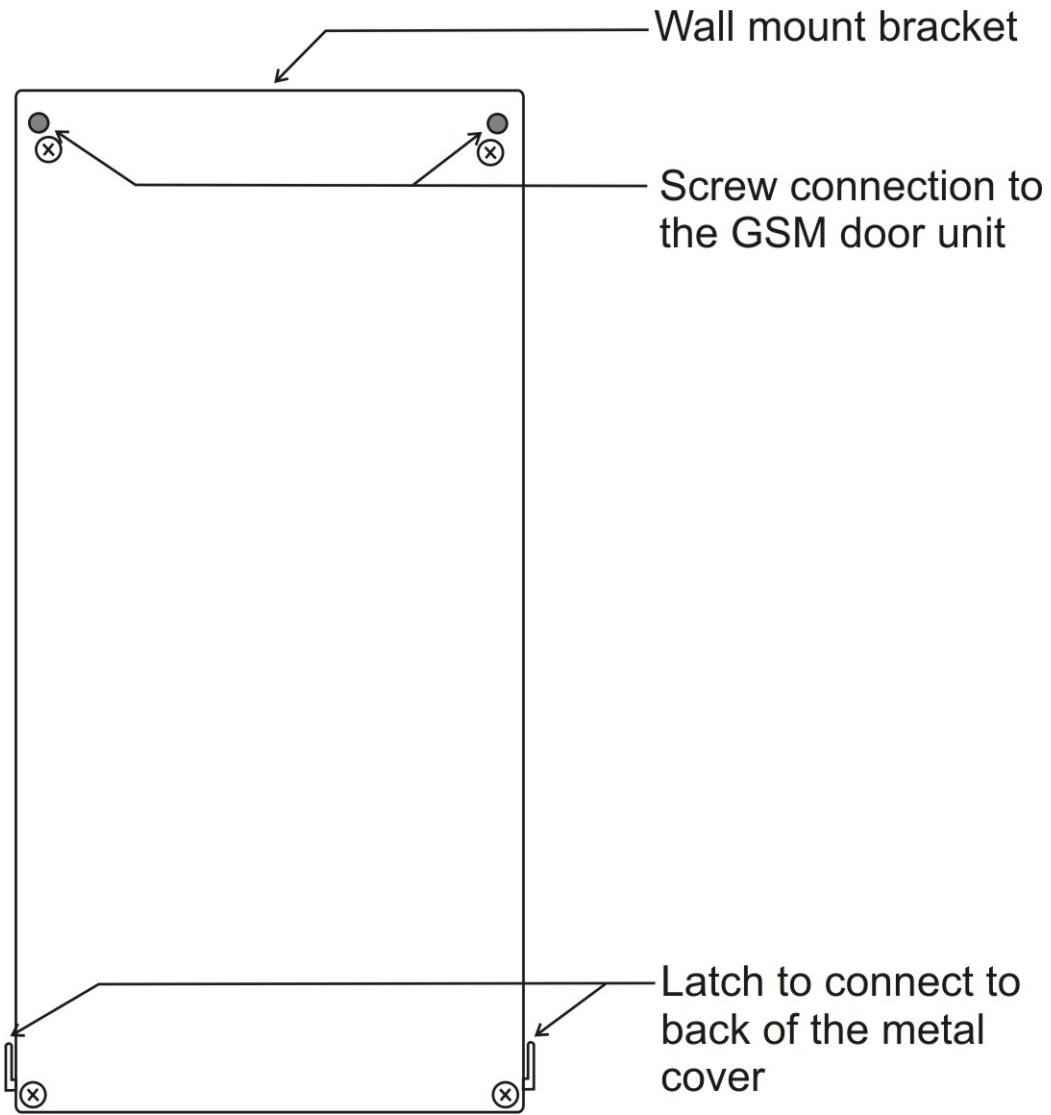

INSTALLATION

GSM Door Phone

1. Take the wall-mount bracket from the package and screw it on proper place (as Step 1 & 2 shown below).
2. Open the bottom cover of door unit and pass the wires through the hole. Then, refer to the “**Wiring Diagram and Wiring Instruction**” to connect wires and insert the SIM card to SIM card slot (as Step 3 shown below).
3. Put the bottom cover back (as Step 4 shown below).
4. Place door unit on the fixed wall-mount bracket (as Step 6 & 7 shown below).
5. Put the acrylic cover on the door unit when door unit has been screwed (as Step 8 & 9 shown below).

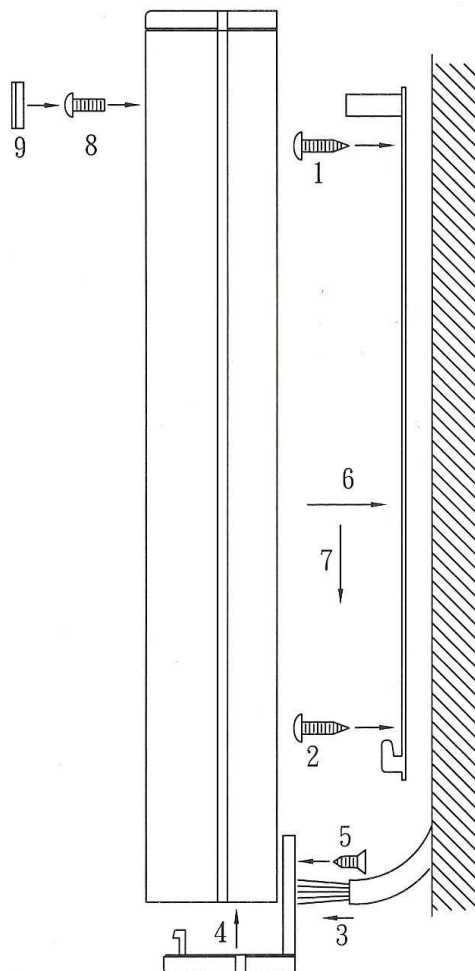

6. Plug the AC adapter into the AC outlet, then the door unit will go into standby mode.

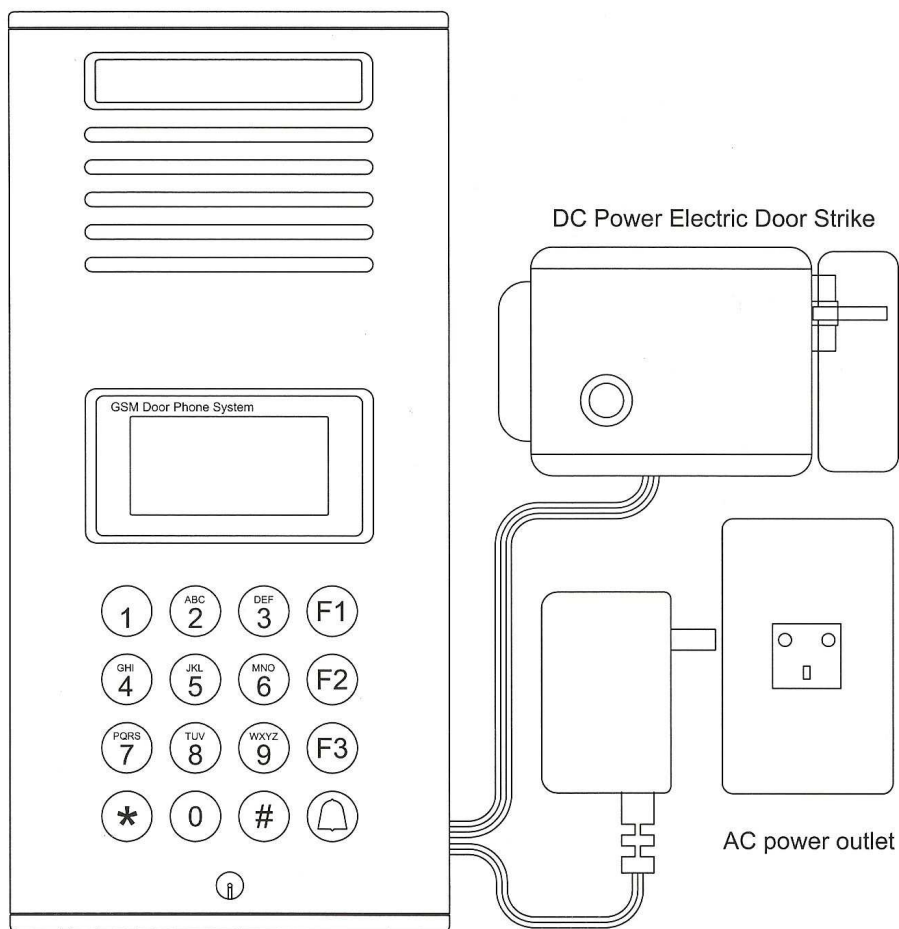

WARNING: Only use the original power adapter supplied. Using any other adapter might damage the door unit and cause a risk of electric shock.

Wiring Instructions

Lock wiring for DC MAG Lock

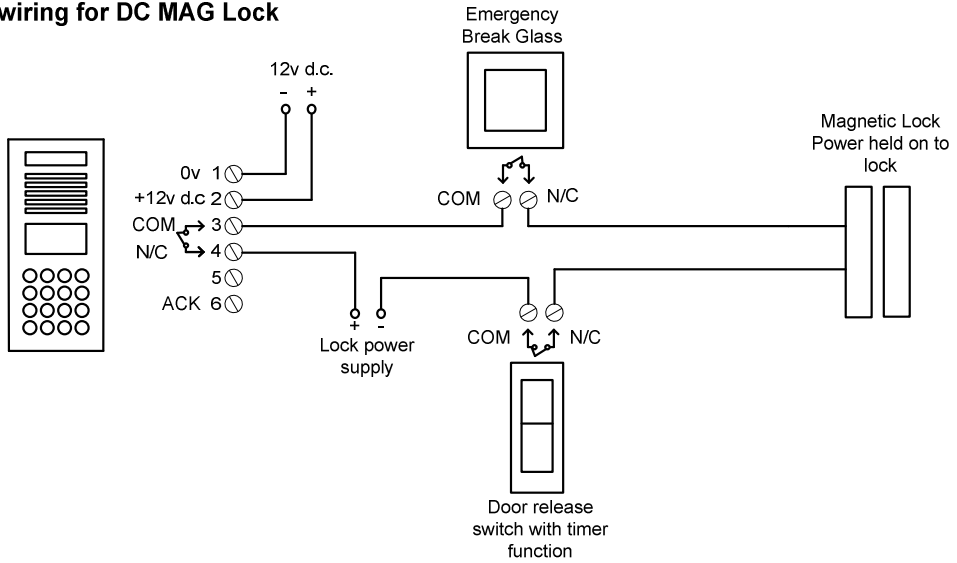

Lock wiring for AC Strike Lock

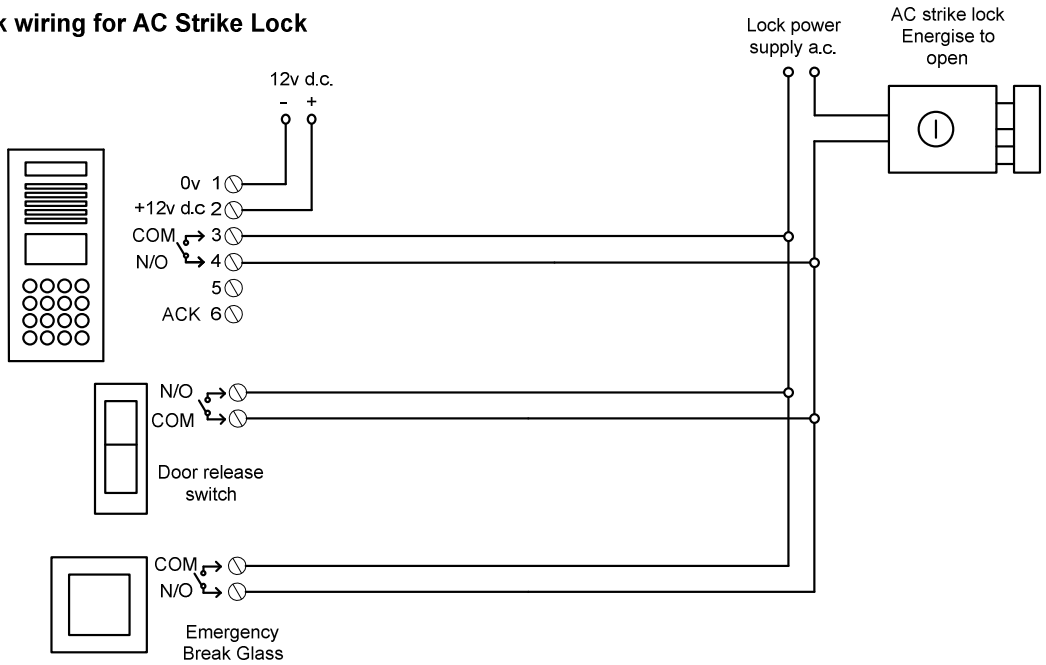

Lock wiring for automatic gates

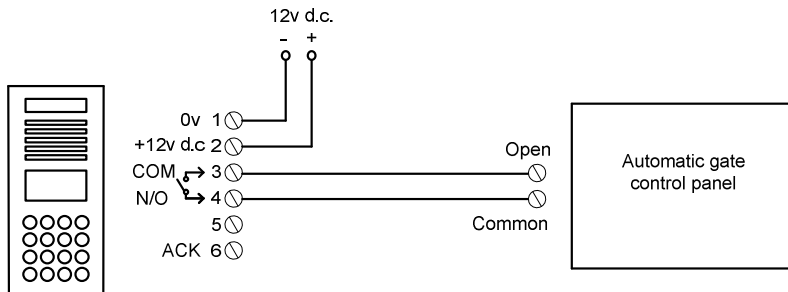

OPERATION

- **Before operation:** Please make sure the GSM Door Phone is installed correctly. Please also study all button functions before use.

Power On/Off

Turn the power on

Insert the plug of the power adapter into the DC power jack of door unit and the other end into an AC power outlet.

When the power is on, the system will emit a “beep” sound, show “GSM Door Phone” and software version on screen, then show “Search Network” for a few seconds, and then go to standby mode.

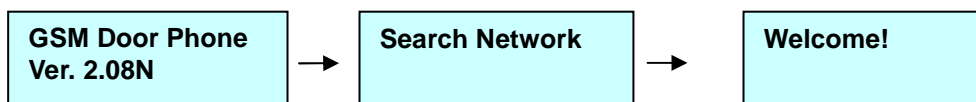

Turn the power off

Turn off the door unit by unplugging the power adapter from the AC power outlet.

Manager Mode and Functions

Note: The unit will be time out after 5 seconds if no button is pressed.

Press **F1 (MENU)** button, and the system will show "Hello! Manager! Password: _____".

Hello! Manager!
Password: _____

After entering default password "123456", press  CALL button to show the button functions as listed below:

CALL: Select/Save
F1: Menu/Exit
F2: Delete
*/#: Move Cursor
▲ ▼

Press any button or wait for 6 seconds, it will show:

Manager
Subscriber

Manager Settings

Under the Manager section, there are 4 main options: “System Setting”, “Volume Setting”, “Door Setting” and “Calling Setting”.

System Setting
Volume Setting
Door Setting
Calling Setting

Press  CALL button to enter System Setting.

Change Password
Manager Phone #
Talking Time

Change Manager Password

Manager Setting → System Setting → Change Password

Note: The Manager Password is the key to enter Programming Mode. Please make sure to keep the Manager Password in a safe place. If you forget the Manager Password, you'll have to do a Master Reset which will delete your stored phone numbers and settings.

Change Password
New: _____
Confirm: _____

Under the Manager Menu option, press  CALL button.

Select **System Setting** and press  CALL button.

Select **Change Password** and press  CALL button.

Enter new password by Number button (must be 6 digits).

Enter password again to confirm and press  CALL button.

Store Manager Phone Number

Manager Setting → System Setting → Manager Phone#



Note: This will be the number that is called when the  CALL button is pressed in standby mode.

Manager Phone #
1:

Under the Manager Menu option, press  CALL button.

Select **System Setting** and press  CALL button.





Select **Manager Phone #** by ***/#** key and press  CALL button.

With cursor on the **1**, press  CALL button to enter phone number
Enter phone number with prefix and area code, then press  CALL button to save.
(If you enter a number incorrectly, use the ***/#** button to move forwards or backwards.
The **F2** (Delete) button will clear a digit you do not want.)
Press **F1** (EXIT) button to return to previous option screen.

Set Minutes for Talking Time

Manager Setting → System Setting → Talking Time

Talking Time
03 Minute(s)

Under the Manager Menu option, press  CALL button.
Select **System Setting** and press  CALL button.
Select **Talking Time** and press  CALL button.
Input the number for minutes you will need for the intercom to be made without re-dial, then press  CALL button to save.
Press **F1** (EXIT) button to return to previous option screen.

Volume Settings



Change Microphone Volume

Manager Setting → Volume Setting → Mic. Volume

Mic. Volume
Speaker Volume

Note: There are 9 levels of sensitivity for the microphone volume going from left (least sensitive) to right (most sensitive). If the GSM Door Phone is installed outdoors, please set the microphone level to 3 or 4. This may help to reduce picking up too much background noise and/or feedback from the speaker.

Mic. Volume
<- * * * * ->

Under the Manager Menu option, press  CALL button.
Select **GSM Setting** and press  CALL button.
Select **Mic. Volume** and press  CALL button.
Press ***/#** (UP/DOWN) buttons to adjust volume.
Press **F1** (EXIT) button to return to the previous option screen and the last setting will be saved automatically.

Change Speaker Volume

Manager Setting → GSM Setting → Speaker Volume

Speaker Volume

<- * * * * ->

Note: There are 9 levels of speaker volume from left (lowest) to right (loudest). If the GSM Door Phone is installed outdoors, please set the speaker level to 4 or 5. Try not to set the speaker volume to the maximum level because it may cause feedback.

Under the Manager Menu option, press  CALL button.

Select **GSM Setting** and press  CALL button.

Select **Speaker Volume** and press  CALL button.

Press ***/#** (UP/DOWN) buttons to adjust volume.

Press **F1** (EXIT) button to return to the previous option screen and the last setting will be saved automatically.

Change Speaker Volume during Conversation

At any time during the conversation, if the caller needs to increase speaker volume, he can press ***/#** (UP/DOWN) buttons to make adjustment. The screen will show the current speaker volume and the microphone will be mute for 1.5 seconds, then the conversation will be continued.

Door Setting

Enable/Disable Door Lock Open by Password

Manager Setting → Door Setting → Open by Password

Open by Password
Opening Password
Door Open Time
Door Relay Type

Open by Password
Enabled

Note: If your GSM Door Phone is connected with an electric door strike, you can activate the password feature to open the door lock with a password. The default password is “123456”.

Under the Manager Menu option, press  CALL button.

Select **Door Setting** and press  CALL button.

Select **Open by Password** and press  CALL button.

Press **CALL** button to toggle between “**Enabled**” and “**Disabled**”.



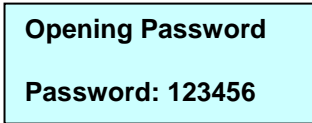

Press **F1** (EXIT) button to return to the previous option screen and the last setting will be saved.

Change Door Opening Password

Manager Setting → Door Setting → Opening Password



Note: This GSM Door Phone system will allow the user to open door by pressing 6-digit password. This feature is designed for easy access control. We suggest to change the Door Opening Password every month or every two weeks for security concern.



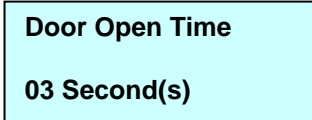

- Under the Manager Menu option, press  CALL button.
- Select **Door Setting** and press  CALL button.
- Select **Opening Password** and press  CALL button.
- Enter password (must be 6 digits).
- Press  CALL button to save the new password.
- Press **F1** (EXIT) button to return to previous option screen.

Door Opening Time

Manager Setting → Door Setting → Door Open Time



Note: This GSM Door Phone system will allow the user to set how long the door lock will be opened. Sometimes, the user might need more time to reach from the door phone unit to the locked main gate. We suggest to set enough time to allow him/her walk in no hurry.

- Under the Manager Menu option, press  CALL button.
- Select **Door Setting** and press  CALL button.
- Select **Door Open Time** and press  CALL button.
- Enter the number of seconds (from 03 to 99).
- Press  CALL button to save.
- Press **F1** (EXIT) button to return to previous options screen.

Calling Setting

Set Calling Time

Manager Setting → Calling Setting → Calling Time

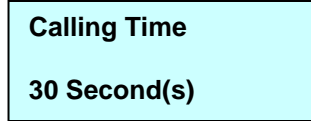
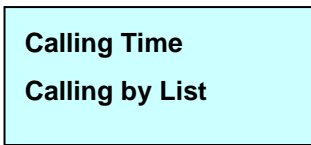

Note: The GSM Door Phone can be set with the calling time by seconds.

Under the Manager Menu option, press  CALL button.

Select **Calling Setting** and press  CALL button.

Select **Calling Time** and press  CALL button.

Press **Number** button to set calling time.

Press **F1** (EXIT) button to return to the previous option screen and the last setting will be saved.

Change the Calling by List

Manager Setting → Calling Setting → Calling by List

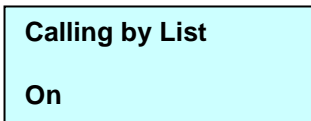

Note: The GSM Door Phone system will allow the user to set the calling by list.

Under the Manager Menu option, press  CALL button.

Select **Calling Setting** and press  CALL button.

Select **Calling by List** and press  CALL button.

Press ***/#** button to adjust On or Off for the Calling by List function.

Press  CALL button to save the function.

Press **F1** (EXIT) button to return to previous option screen.

Subscriber:

The Subscriber function supports to set up multiple tenants and enable the user to press a subscriber number by the  CALL button to connect with the tenant. A subscriber ID # can be set from 1 to 6 digits in length. There are maximum 263 subscribers which can have 2

phone numbers programmed for each.

The first registered phone number will be the first number that the GSM Door Phone will call. If the first registered number is busy or no one answers the call, the door phone will automatically dial the second registered number. We suggest that the first number can be the home phone number and the second number can be a mobile phone number.

Subscriber ID Number Setup

Subscriber Setting → Enter Subscriber ID: _

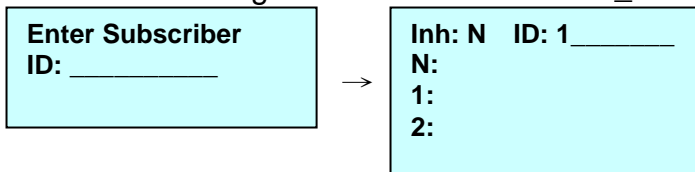

Select **Subscriber** Menu option and press  CALL button.
You can choose from 1 digit to 6 digits for the Subscriber ID.

Enter Subscriber ID “_____” and press  CALL button.

Press **1** button and press  CALL button to start input of the first tenant information.

While the cursor is moved to “**N**” (Name) position, press  CALL button, and then you can enter the tenant’s name by 2~9 Number buttons. (Use F3 button to select ABC or abc, 0 button = space button).

Move cursor to **1** by ***/#** button and press  CALL button to enter. Enter the first phone number with area code, then press  CALL button to save.

Move cursor to **2** by ***/#** button and press  CALL button to enter. Enter the second phone number with area code, then press  CALL button to save.

Press **F1** (EXIT) button to exit.

(**Note:** Follow above steps to set the other tenant’s name and phone number.)

Contact a Subscriber

Under the "Welcome!" mode, enter **User ID number** (from 1 ~ 999999) and then press  CALL button.

If the ID exists, the system will start dialing and show “**Calling...**” on the screen. When the phone is connected, the screen will show “Talking”.

Calling- - -

Talking- - -



If the ID does not exist, the screen will show “Incorrect!”.

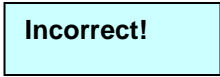

If the ID exists, but there is no number assigned, the screen will show “Calling...”, but will never connect and then time out after 3 minutes. In order to avoid this problem, please make sure to input the phone number on each User ID.

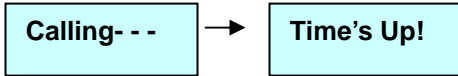

If the dialing fails, the screen will show “No dial tone” and go back to standby mode.

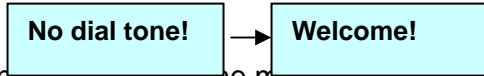

If the call is not answered within one minute, the screen will show “No answer” and go back to standby mode.

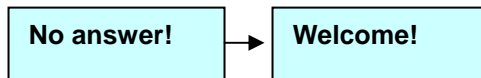

During conversation, if the other party hangs up or the line is cut, the screen will show “No carrier” and go back to standby mode.

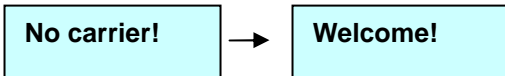

During conversation or while dialing, pressing **F1** (Menu/Exit) or **F2** (Delete/Cancel) button will stop the conversation.

Open the Door Remotely

During conversation, the called party can press the button to open the door. The door-open time can be set by user. The default setting is 3 seconds.

Go Back to Standby Screen Automatically

If the manager password has been entered and no button is pressed within 30 seconds, the screen will go back to the standby mode – “Welcome!”

If a **Subscriber ID** is entered and no button is pressed within 6 seconds, the screen will go back to the standby mode.

If no button is pressed within 30 seconds under the **Manager** or **Subscriber** option, the screen will go back to the standby mode.

SIM Card

If the SIM card is not inserted, the screen will show “SIM not Inserted” when the system is turned on.

SIM not Inserted

Call Manager

If “Manager Phone #” has been programmed, the system will directly dial this number while the visitor presses  CALL button at the standby mode.

If “Manager Phone #” is not stored, no action will be taken by pressing the  CALL button

Master Reset

The following operation will make the unit back to factory default. Please note that this will erase all passwords, phone numbers and subscribers.

At the Standby mode, press **F2(C)**, *****(UP), *****(UP), *****(UP), **#**(DOWN), **#**(DOWN), **#**(DOWN) and  **CALL** buttons in sequence. It will show “Initial System Please Wait...”, then all is back to default.